

S8550

PNP Silicon Epitaxial Planar Transistor

for switching and amplifier applications.
Especially suitable for AF-driver stages
and low power output stages.

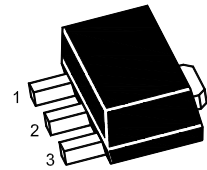

1.Base 2.Collector 3.Emitter
SOT-89 Plastic Package

Absolute Maximum Ratings ($T_a = 25\text{ }^\circ\text{C}$)

Parameter	Symbol	Value	Unit
Collector Base Voltage	$-V_{CBO}$	40	V
Collector Emitter Voltage	$-V_{CEO}$	25	V
Emitter Base Voltage	$-V_{EBO}$	6	V
Collector Current	$-I_C$	1.5	A
Power Dissipation	P_{tot}	625	mW
Junction Temperature	T_j	150	$^\circ\text{C}$
Storage Temperature Range	T_{Stg}	- 55 to + 150	$^\circ\text{C}$

Characteristics at $T_a = 25\text{ }^\circ\text{C}$

Parameter	Symbol	Min.	Typ.	Max.	Unit
DC Current Gain at $-V_{CE} = 1\text{ V}$, $-I_C = 5\text{ mA}$ at $-V_{CE} = 1\text{ V}$, $-I_C = 100\text{ mA}$ at $-V_{CE} = 1\text{ V}$, $-I_C = 800\text{ mA}$	Current Gain Group C D	h_{FE}	45	-	-
		h_{FE}	120	-	200
		h_{FE}	160	-	300
		h_{FE}	40	-	-
Collector Base Cutoff Current at $-V_{CB} = 35\text{ V}$	$-I_{CBO}$	-	-	100	nA
Emitter Base Cutoff Current at $-V_{BE} = 6\text{ V}$	$-I_{EBO}$	-	-	100	nA
Collector Base Breakdown Voltage at $-I_C = 100\text{ }\mu\text{A}$	$-V_{(BR)CBO}$	40	-	-	V
Collector Emitter Breakdown Voltage at $-I_C = 2\text{ mA}$	$-V_{(BR)CEO}$	25	-	-	V
Emitter Base Breakdown Voltage at $-I_E = 100\text{ }\mu\text{A}$	$-V_{(BR)EBO}$	6	-	-	V
Collector Emitter Saturation Voltage at $-I_C = 800\text{ mA}$, $-I_B = 80\text{ mA}$	$-V_{CE(sat)}$	-	-	0.5	V
Base Emitter Saturation Voltage at $-I_C = 800\text{ mA}$, $-I_B = 80\text{ mA}$	$-V_{BE(sat)}$	-	-	1.2	V
Base Emitter Voltage at $-I_C = 10\text{ mA}$, $-V_{CE} = 1\text{ V}$	$-V_{BE}$	-	-	1	V
Gain Bandwidth Product at $-V_{CE} = 10\text{ V}$, $-I_C = 50\text{ mA}$	f_T	120	-	-	MHz
Collector Base Capacitance at $-V_{CB} = 10\text{ V}$, $f = 1\text{ MHz}$	C_{ob}	-	15	-	pF

S8550

Typical Characteristics

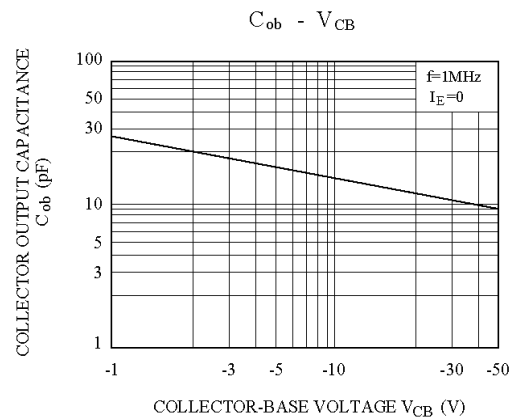
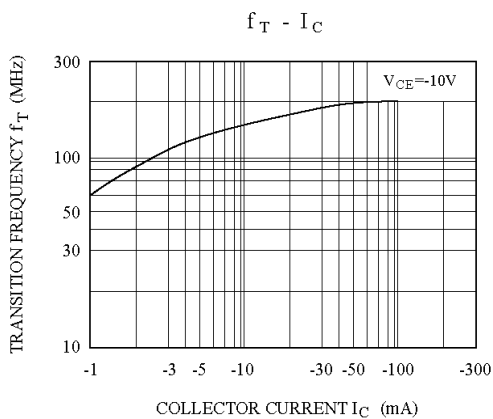
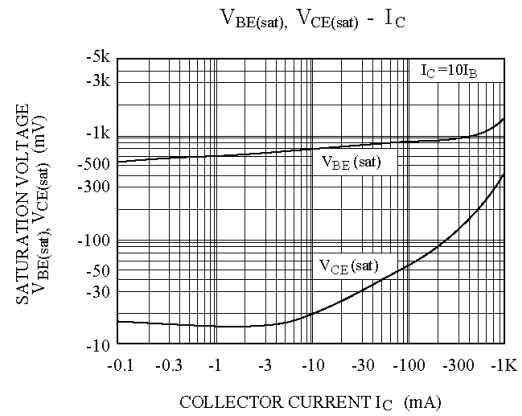
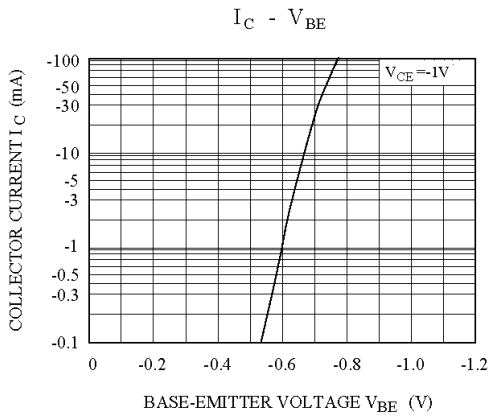
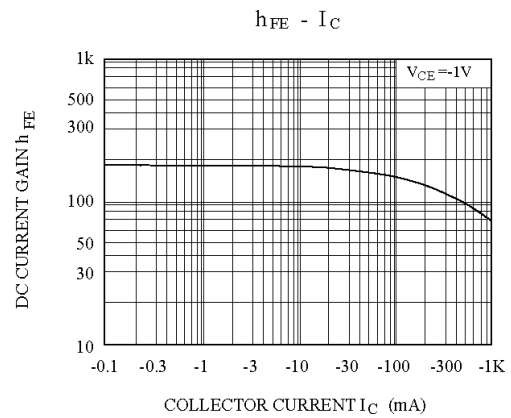
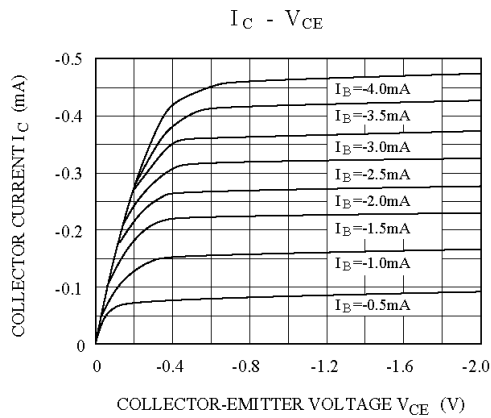

S8550

SOT-89 PACKAGE OUTLINE

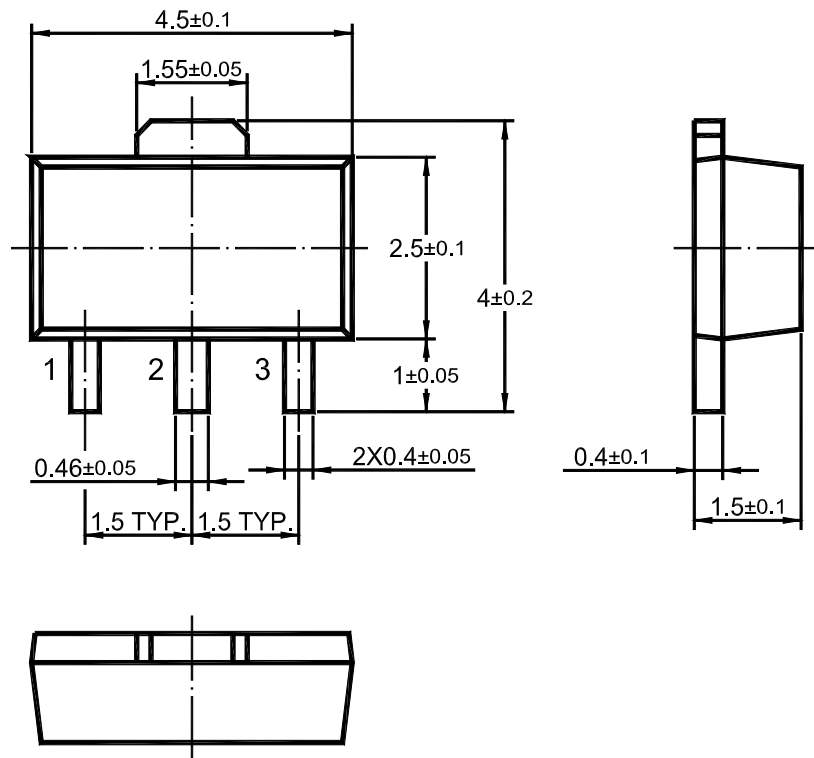

Dimensions in mm